

**Gallotti&Radice**



# Milano 1

2011

Executive desk with structure and drawers in natural ash, tobacco stained or black open pore lacquered ash. One side resting on Milano unit with doors and drawers (front) and open (back) with 10mm glass shelves in the same finish of the glass top. 15mm transparent or extralight glass top. Also available with 12mm smoked "grigio Italia" tempered glass top. Suede writing pad as per samples. Unit available on the right or left side. Position to be confirmed when placing the order. Without this information, the unit will be on the right side.

Cm (L x W x H)

236 x 180 x 75

286 x 180 x 75

Sottomano / Writing pad

50 x 57

100 x 57

Inches (L x W x H)

93 x 71 x 29<sup>3</sup>/<sub>4</sub>

112<sup>3</sup>/<sub>4</sub> x 71 x 29<sup>3</sup>/<sub>4</sub>

Sottomano / Writing pad

19<sup>3</sup>/<sub>4</sub> x 22<sup>1</sup>/<sub>2</sub>

39<sup>1</sup>/<sub>2</sub> x 22<sup>1</sup>/<sub>2</sub>

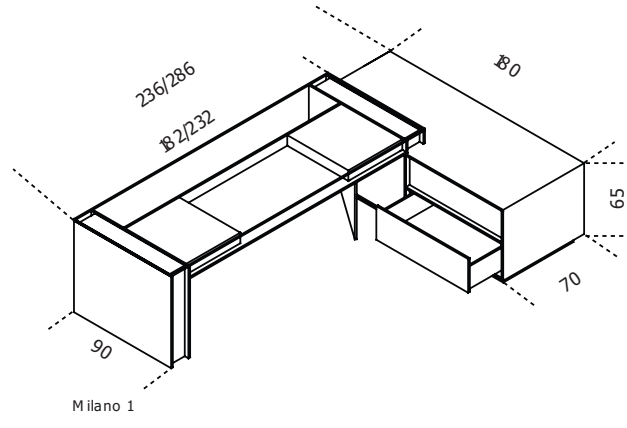
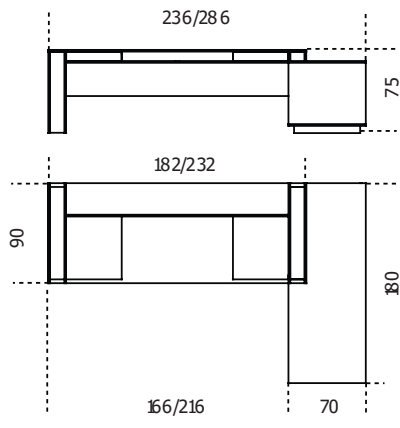

# Finishings

## Glass



"Grigio Italia"



Extralight

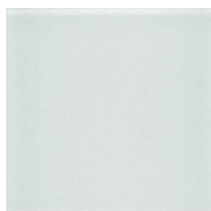

Transparent

## Wood



Black open pore  
lacquered ash



Natural ash

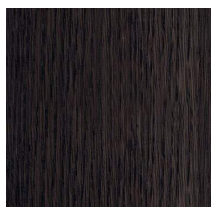

Tobacco stained  
ash

## Leather Cat.L1

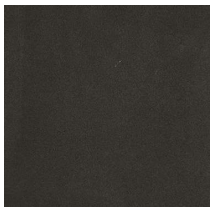

Suede grey 020

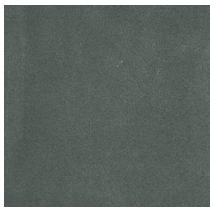

Suede grey 058

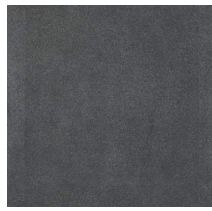

Suede grey 074

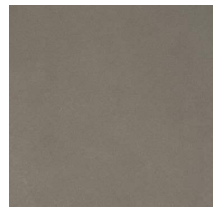

Suede sand 006



Suede sand 012